

Graphic Display and Exhibit Systems

Display- och Utställningssystem



Vario d1
Folding display
Vikdisplay



Vario d2
Portable Version
Portabel version



Vario d2
Banner display
Banderolldisplay



Vario d3
Folding display
Vikskärm



Vario d4
Pop Up fabric
Pop Up textil



Vario d5
Promotion display
Promotion display



Vario d7
Column display
Pelardisplay



Vario d2 Original
Frame display
Ramdisplay



Vario d2
Window and
table top display
Skylltönsterdisplay



Vario d2
Counter
Disk



Vario d4
Pop Up
Pop Up

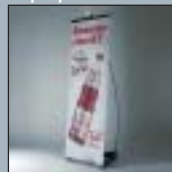

Vario d5 Original
Promotion display
Promotion display



Vario d5 Pocket
Literature display
Broschyr display



Vario d10
Rollup display
Rullgardinsdisplay

Vario Display Product Catalogue

Vario Display Produktkatalog

Expertise with Creative Systems
Kompetens för kreativa system



Graphic Display and Exhibit Systems

Display- och Utställningssystem

The world of presentation

Displays emphasize and draw attention – whether at trade shows or events or in stores, banks, or other points of sale.

Promotion is essential for all companies and organizations that want to be noticed and create relationships with potential customers or alliance partners.

Every presentation is individual, whether given with or without the help of tools. Success often depends on the presenter's ability to use and underline, that which is unique and individual about the message.

OCTANORM meets every demand with a comprehensive array of display and presentation solutions. In recent years, we have successfully developed the vario display product line. Its design, versatility and simplicity give entirely new dimensions and options to the art of making effective presentations. When you put vario display to work, you create the medium you need to reinforce and highlight the message. It doesn't matter whether the message is major or minor – there is a vario application for every need.

They range from simple rolling displays to more sophisticated solutions with built-in lighting. Vario's versatility allows for everything from a stable frame construction for a simple display to a modular system built for large-format pictures. All display and presentation systems meet the quality standards that apply to all OCTANORM products: high quality materials, fast handling, elegantly simple construction and attractive design.

Make your presentation a success – let vario display highlight the message.

The world of presentation

Displayer betonar och väcker uppmärksamhet – oavsett om det är på mässor eller events, i butiker, banker eller andra "point of sales".

Presentationer är helt nödvändiga för alla typer av företag och organisationer som vill synas och skapa relationer med potentiella kunder eller samarbetspartners.

Varje presentation är individuell, oavsett om den sker med eller utan hjälpmedel. Förmågan att använda och understryka det individuella i budskapet avgör ofta framgången.

OCTANORM möter alla krav med en rad olika display- och presentationslösningar.

Under de senaste åren har vi med stor framgång utvecklat vario display som genom sin konstruktion, smidighet och enkelhet ger helt nya dimensioner och möjligheter i konsten att göra framgångsrika presentationer. Med vario display skapas den miljö som behövs för att förstärka och lyfta fram budskap. Små eller stora budskap spelar ingen roll. Det finns alltid en varioapplikation till varje behov.

Det kan vara från enkla rulldisplayer till mer kvalificerade lösningar med inbyggd belysning. Flexibiliteten kan göra en stabil ramkonstruktion till en enkel display eller ett modulsystem byggbart för storbilder. Alla display- och presentationssystem uppfyller de kvalitetsnormer som gäller för alla OCTANORMs produkter – hög materialkvalitet, snabb hantering, enkel konstruktionsprincip och tilltalande design.

Gör presentationen framgångsrik – låt vario display lyfta budskapen.



Vario d1
Folding display
Vikdisplay

Variable folding display systems for large scale impact
Variabelt vikdisplayssystem för stora ytor

4



Vario d2 Original
Frame display
Ramdisplay

Versatile frame system made of high grade anodized aluminium
Tekniskt ramsystem av högvärdig eloxerad aluminium

6



Vario d2
Portable version
Portabel version

A big impact with small dimensions
Stor föreläsning med små mått

8



Vario d2
Window and tabletop display
Skyllfönsterdisplay

An active sales aid in the shop window
Aktiva säljhjälpmedel i skyltfönstret

10



Vario d2
Banner display
Banderolldisplay

Effective presentation with textile prints
Effektfull presentation på textila tryck

12

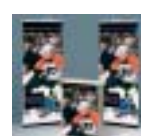

Vario d2
Counter
Disk

An elegant assistant for your presentation
Elegant hjälp för din presentation

14

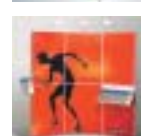

Vario d3
Folding display
Vikskärm

Classic folding screen for fast presentation
Klassisk vikskärm för snabb presentation

16

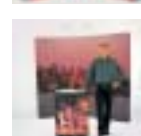

Vario d4
Pop Up
Pop Up

Stable & robust: for those who want to be noticed
Stabil & robust för alla som vill synas

18



Vario d4
Pop Up fabric
Pop Up textil

The optimal solution for effective presentations
Det optimala för effektfulla presentationer

20



Vario d5 Original
Promotion display
Promotion display

The revolution in promotion displays
Revolutionen bland reklamdisplayer

22

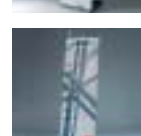

Vario d5 String
Promotion display
Promotion display

Ideal P.O.S. display, no tool assembly
Idealisk display vid kassan, monteras utan verktyg

24



Vario d5 Pocket
Literature display
Broschyr display

A portable literature stand
Broschyrhyllan att ta med

26

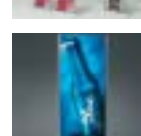

Vario d7
Column display
Pelardisplay

Illuminated promotional messages in the optimum framework
Lysande reklambudskap i optimal ram

28



Vario d10
Rollup display
Rullgardinsdisplay

Quick and easy banner presentation
Snabb och enkel banderollpresentation

30

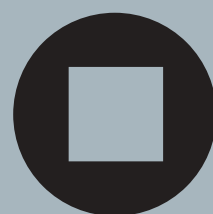

vario d1

Folding display/Vikdisplay



Model example: VA 1680, VA 5036, VA 5032, 3 x VA 5021
Recommended panel: 1mm PVC
Modell exempel: VA 1680, VA 5036, VA 5032, 3 st. VA 5021
Rekommenderad panel: 1 mm PVC

- Quick and easy set up, various configurations and the possibility of making an impact in a large format – these are the main features of the vario d1 folding display. Four basic modules (from 700x1000mm to 2800x2000mm) offer a variety of presentation formats. From one individual element to a combination of 8. The lateral OCTA-NORM system groove means you can attach accessories. The panels are quick and easy to affix using magnetic strips. With extras such as spotlights, transport bags and brochure holders, vario d1 makes an extremely versatile presentation system.

- Enkel, snabb uppbyggnad, variabla utformningsmöjligheter och möjlighet till en effektiv plan yta, är viktiga egenskaper för vikdisplayen vario d1. Fyra basmoduler (från 700x1000mm till 2800x2000mm) möjliggör olika presentationsformer. Från en modul upp till en kombination av 8 moduler. Ytterligare anslutningar kan göras tack vare OCTANORM-systemspår i sidan. Panelen fästs snabbt, enkelt och utan problem med magnetband. Extra tillbehör som t ex spotlights, transportväskor och prospekthyllor gör vario d1 till ett presentationssystem med stort användningsområde.



VA 6001
Stabilizer (t-leg) for in-line configuration.
Stabilisering vid rakt byggsätt.

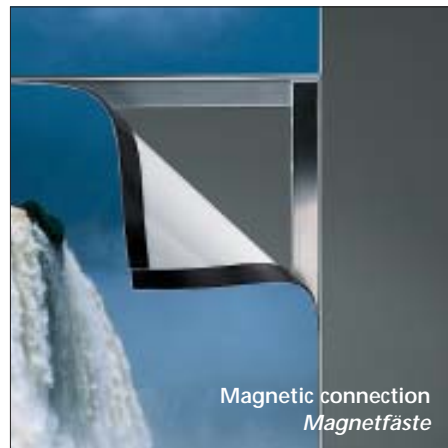

Magnetic connection
Magnetfäste

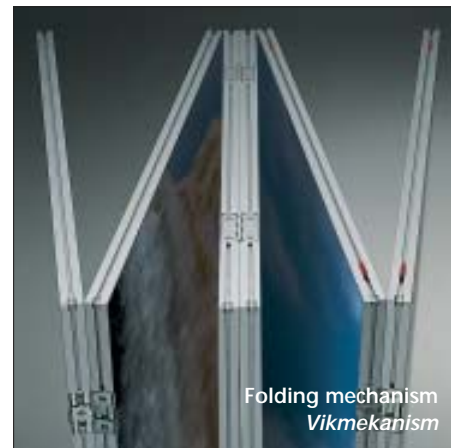

Folding mechanism
Vikmekanism

Basic Modules/Grundmoduler



VA 1180
Single frame, 700x1000mm
Enkelram, 700x1000mm



VA 1480
4-Module, 700x1000mm
4 modul, 700x1000mm

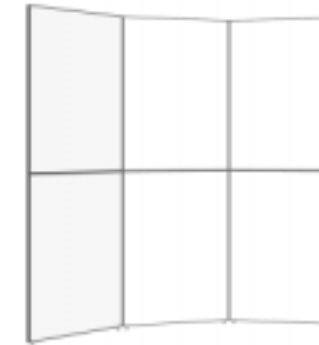

VA 1680
6-Module, 700x1000mm
6 modul, 700x1000mm

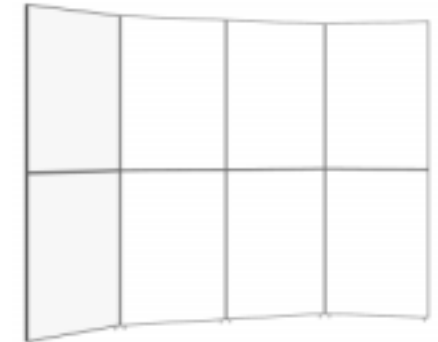

VA 1880
8-Module, 700x1000mm
8 modul, 700x1000mm

Measurement correspond to panel size. System prepared for panels on 1 side.
Angivna mått avser storlek på panel. Systemen är förberedda för paneler på 1 sida.

Accessories/Tillbehör



VA 2180
Top frame
Topfram



VA 5035
Magnetic strip, 30m, self-adhesive
Magnetband, 30m, självhäftande



VA 5045
Steel strip, 30m, self-adhesive
Stålbånd, 30m, självhäftande



VA 6001
T-leg, set of two
Stödben, par

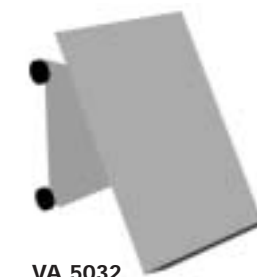

VA 5032
Literature holder, right side
Broschyrhylla, höger sida



VA 5019
Connector for upper and lower frames
Skarv för övre och undre ramar



VA 5036
Literature holder, left side
Broschyrhylla, vänster sida



VA 5021
Spotlight 230V/200W
Spotlight 230V/200W
VA 5021/110
Spotlight 120V/200W
Spotlight 120V/200W

VA 1013
Accessory bag, L.750, D.400, H.400mm
Tillbehörsväska, L.750, B.400, H.400mm



VA 1011
Transport bag for max one 8-module
L.1070, D.270, H.750mm
Transportväska för max en 8-modul
L.1070, B.270, H.750mm



Technical Information/Teknisk information

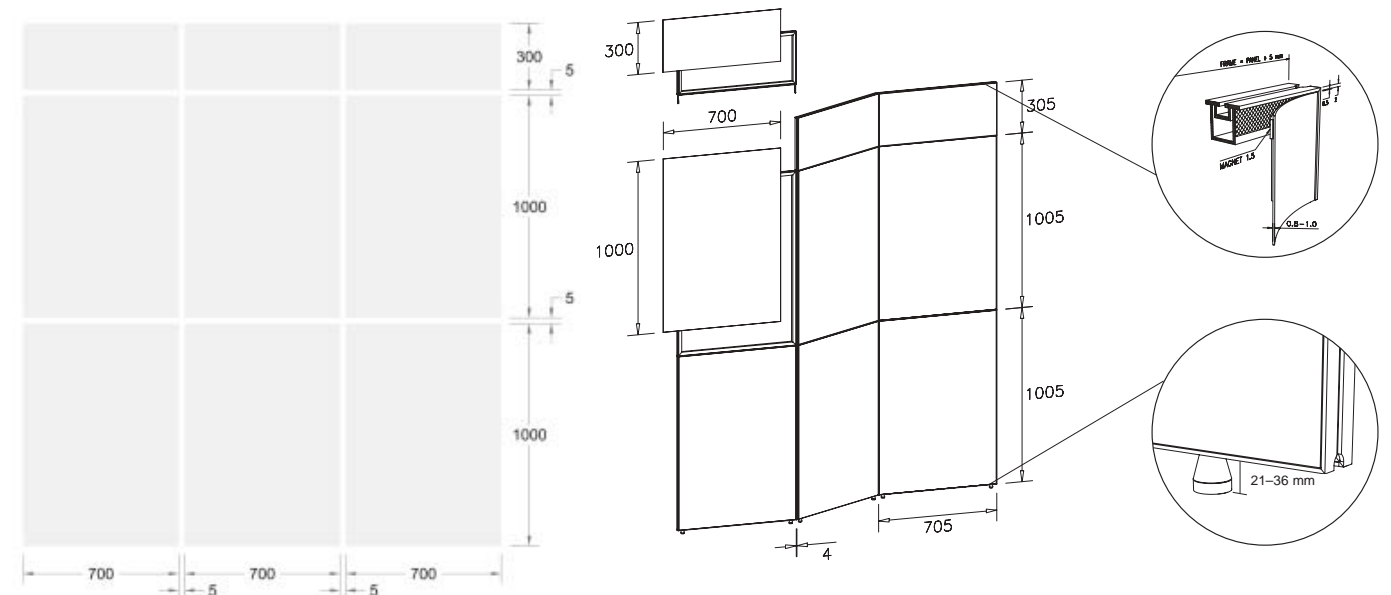

vario d2 Original

Frame display/Ramdisplay



• Visually striking display with straight or curved frames on which promotional messages can be effectively displayed. Thanks to the seamless connection system you can combine as many frames as you like. The OCTANORM system groove on the sides allows for many different add-ons. It can also be supplemented with spotlights, transport bags and brochure holders. The high-grade anodized aluminium supports and beams account for the technical character of this display. Its lightweight and easy assembly make the vario d2 an important standard display unit.

• Utseendemässigt markant display med rak eller svängd ram på vilken reklambudskapet presenteras effektivt. Tack vare skarvfri anslutning kan ett valfritt antal ramar sammanfogas. OCTANORM-systemspår i sidan möjliggör många anslutningar. Kan även kompletteras med spotlights, transportväskor och prospekthyllor. Dekorstolparna och sargerna av högvärdig, eloxerad aluminium ger displayen dess tekniska karaktär. Låg vikt och enkel uppbyggnad gör vario d2 till en viktig standarddisplay.

Model example: 3 x VA 1275, 2 x M 249, 2 x VA 5037, 2 x M 1440, 4 x VA 5038, VA 5036, VA 5032, 3 x VA 5021
Panel recommendation: from 0.7mm to 1.0mm PVC
Modellexempel: 3 st VA 1275, 2 st M 249, 2 st VA 5037, 2 st M 1440, 4 st VA 5038, VA 5036, VA 5032, 3 st VA 5021
Rekommenderad panel: från 0,7 mm till 1,0 mm PVC



VA 5036



M 1440



M 1443



VA 5021

Basic Modules/Grundmoduler

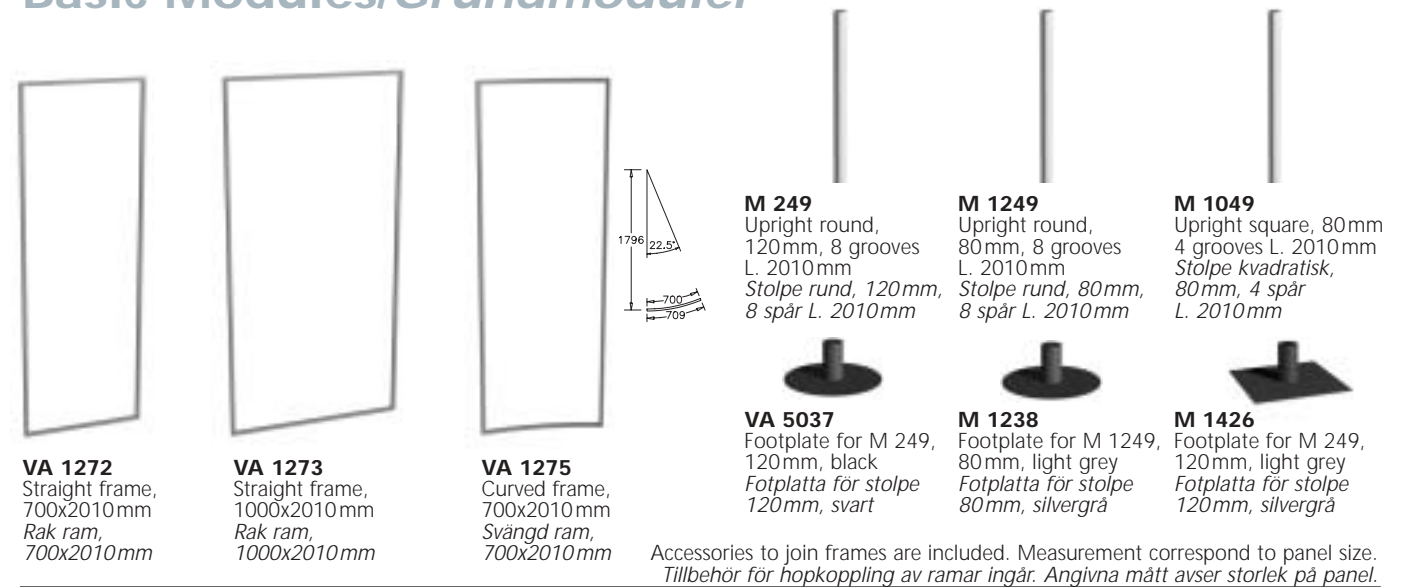

Accessories/Tillbehör

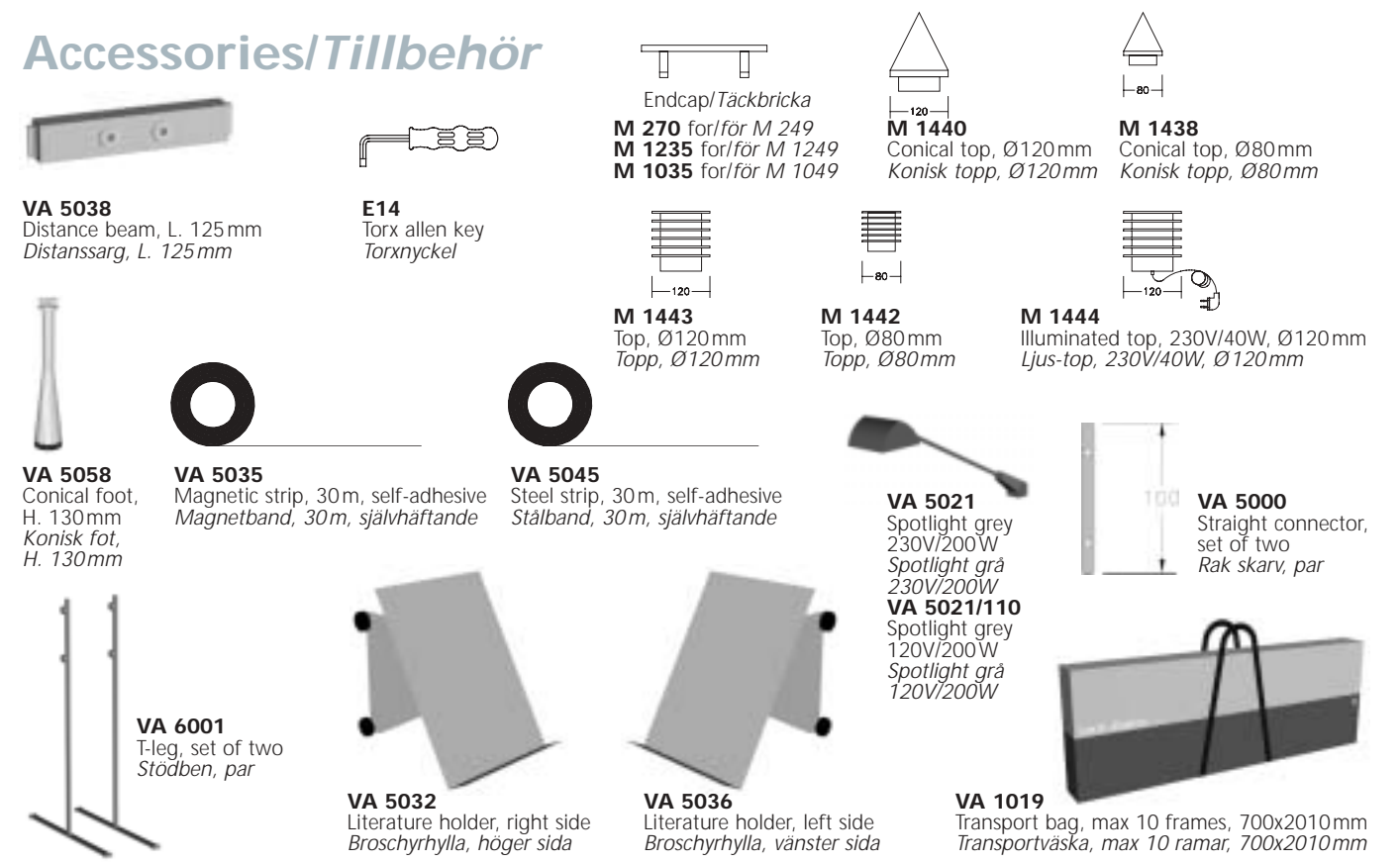

Technical Information/Teknisk information

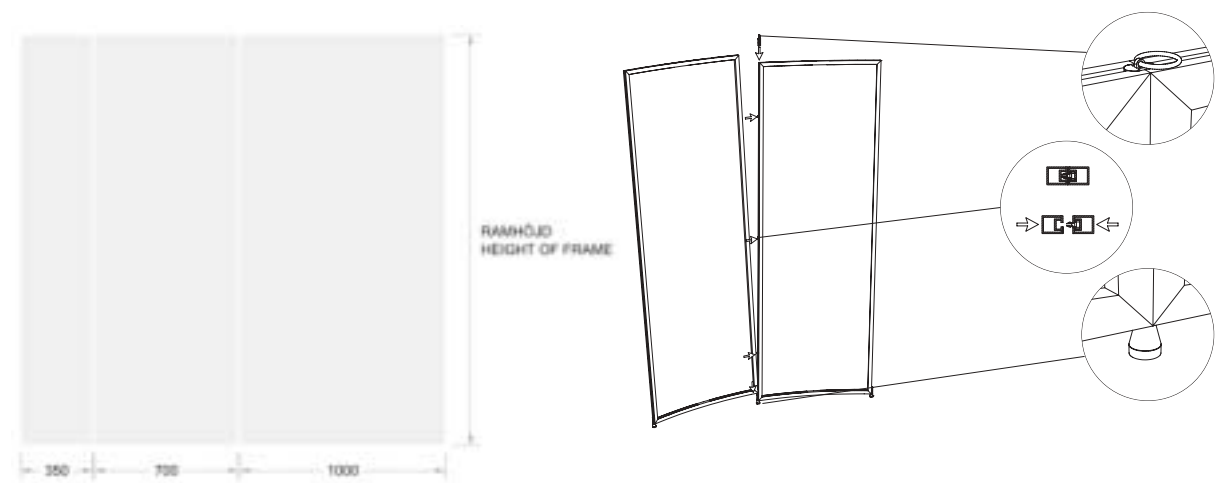

vario d2

Portable Version/Portabel version



- The display for an uncomplicated professional impact. Visually, technically and in its flexibility it corresponds to the Vario d2 Original, but it differs on one very significant point: the supports and beams are knockdown. This allows it to be transported by car or courier. Another advantage: all the accessories and add-ons from the Vario d2 original can be used with this portable version as well. That makes it the optimum extra for big displays that need to be put up with minimal expense.

- Displayen för en okomplicerad och professionell presentation. Motsvarar utseendemässigt, tekniskt och till sin flexibilitet vario d2 Original, men skiljer sig från denna på en mycket väsentlig punkt: dekorstolpar och sarger är delade. Det gör den nedmonterad så liten, att den till och med kan transporteras i en personbil. En ytterligare fördel – alla tillbehörs- och kompletteringsdelar från vario d2 Original-programmet kan även användas till den här bärbara versionen. Det gör den till en optimal komplettering för stora presentationer som det gäller att anordna med minsta möjliga arbete.



Basic Modules/Grundmoduler



VA 1253
Straight frame,
700x1005 mm
Rak ram,
700x1005 mm

VA 1255
Straight frame,
1000x1005 mm
Rak ram,
1000x1005 mm

VA 1254
Straight frame,
700x1240 mm
Rak ram,
700x1240 mm

VA 1256
Straight frame,
1000x1240 mm
Rak ram,
1000x1240 mm

VA 1263
Curved frame,
700x1005 mm
Svängd ram,
700x1005 mm

VA 1264
Curved frame,
700x1240 mm
Svängd ram,
700x1240 mm

Accessories to join frames are included. Measurement correspond to panel size.
Tillbehör för hopkoppling av ramar ingår. Angivna mått avser storlek på panel.

Accessories/Tillbehör



VA 5038
Distance beam, L. 125 mm
Distanssarg, L. 125 mm



VA 5037
Footplate for M 249,
black
Fotplatta för stolpe
120 mm, svart



VA 5000
Straight connector, set of two
Rak skarv, par



VA 1011
Transport bag, max 10 frames, 700x1005 mm
Transportväska, max 10 ramar, 700x1005 mm



M 247
Upright round, 120 mm,
8 grooves
L. 1005 mm
Stolpe rund, 120 mm,
8 spår L. 1005 mm



M 248
Upright round, 120 mm,
8 grooves
L. 1240 mm
Stolpe rund, 120 mm,
8 spår L. 1240 mm



M 1440
Conical top, 120 mm
Konisk topp, 120 mm



VA 1016
Transport bag, max 10 frames, 700x1240 mm
Transportväska, max 10 ramar, 700x1240 mm

Other uprights on request/Andra stolpar på förfrågan.

More accessories, see page 7 and 11/Ytterligare tillbehör se sid 7 och 11.

Technical Information/Teknisk information

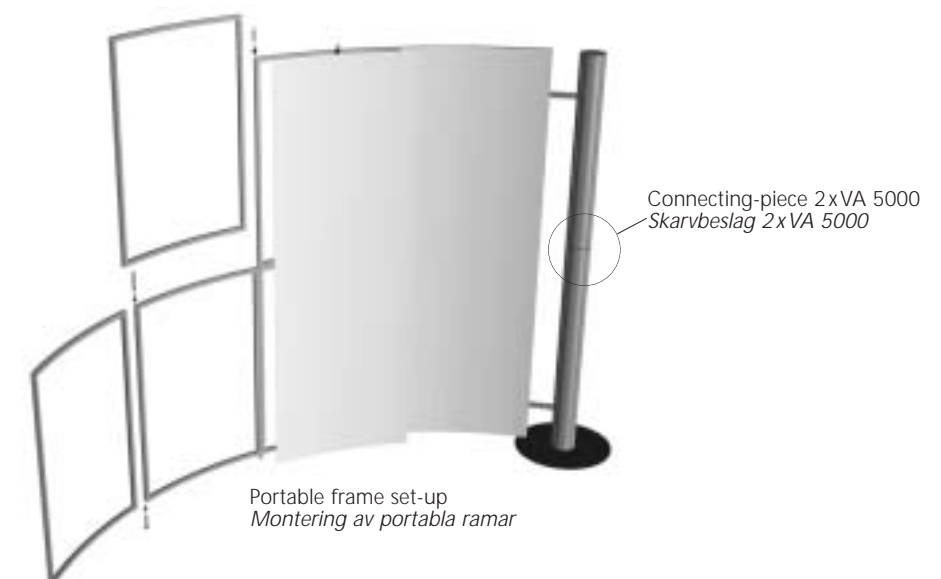

vario d2

Window and table top display/Skyltfönsterdisplay



Model example standing: VA 1249, VA 8702, 2 x VA 6003
Model example hanging: VA 1249, 2 x E 218
Modellexempel stående: VA 1249, VA 8702, 2 st VA 6003
Modellexempel hängande: VA 1249, 2 st E 218

• The last word in high-impact presentation for promotional messages. In the display window or on the sales floor, this display is highly versatile. It can be free standing or it can be hung from the ceiling with ring hooks. If you like, it can be supplied with steel strips on both sides, making it ready to use for advertising displays in the sales area. The detachable spotlight shows important information in the right light. It comes in A1 as standard but other formats are available on request.

The vario d2 window display is equally suitable for specific individual items and for big, bold whole-window formats. Ideal as well as a table top display in lobbies or for conferences.

• Tusenkonstnären för presentation av reklam-budskap med stort uppmärksamhetsvärde. I skyltfönstret eller i försäljningslokalen. För den här displayen är förändringsbar. Med stödfötter går den att utöka hur som helst. Försedd med ringar kan den hängas från taket. Om så önskas, kan den levereras med stålband på båda sidor och kan då användas som reklammyta både i skyltfönstret och in mot försäljningslokalen. Och den påstickbara spotlightsen tar fram innehållet i rätt ljus. Standardformat är A1, andra format kan offereras.

vario d2 skyltfönsterdisplay är lika lämplig för enstaka aktioner som för skyltfönstertytor som kräver stora plakat.

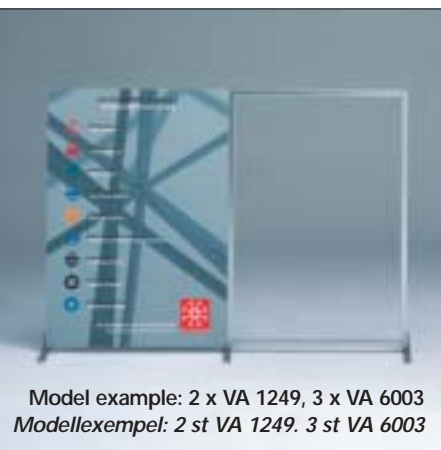

Model example: 2 x VA 1249, 3 x VA 6003
Modellexempel: 2 st VA 1249, 3 st VA 6003

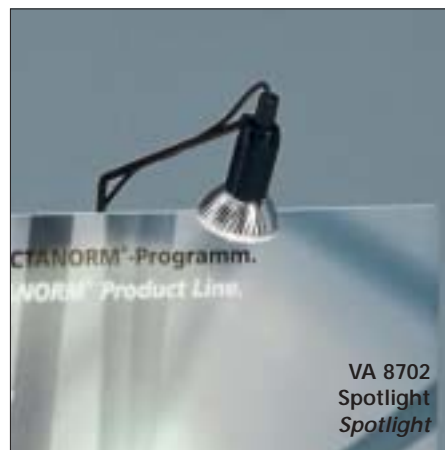

VA 8702
Spotlight
Spotlight



E 218
Ring hook
Ring

Basic Modules/Grundmoduler



VA 1249
Straight frame,
594x841mm, A1
Rak ram,
594x841mm, A1



VA 1253
Straight frame,
700x1005mm
Rak ram,
700x1005mm



VA 1255
Straight frame,
1000x1005mm
Rak ram,
1000x1005mm

Measurement correspond to panel size. Frames prepared for panels on 1 side.
Angivna mått avser storlek på panel. Ramarna är förberedda för paneler på 1 sida.

Accessories/Tillbehör



VA 6003
Floor foot
Golvfot



E 218
Ring screw
Ring skruv



VA 8702
Spotlight 230V/75W
Spotlight 230V/75W
VA 8702/110
Spotlight 120V/50W
Spotlight 120V/50W

VA 8710
Extra bulb 230V/75W
Ljuskälla 230V/75W
VA 8711
Extra bulb 120V/50W
Ljuskälla 120V/50W



VA 5035
Magnetic strip, 30m, self-adhesive
Magnetband, 30m, självhäftande



VA 5045
Steel strip, 30m, self-adhesive
Stålband, 30m, självhäftande

More accessories, see page 7, 9 and 13/Ytterligare tillbehör se sid 7, 9 och 13.

Technical Information/Teknisk information

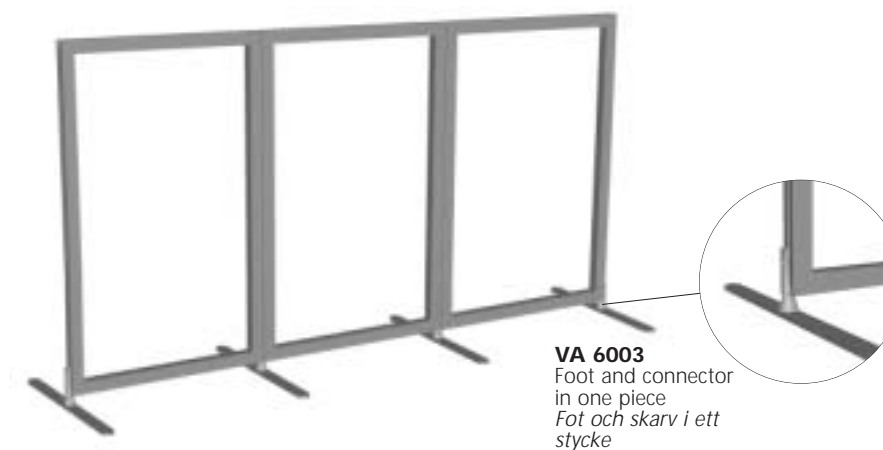

VA 6003
Foot and connector
in one piece
Fot och skarv i ett
stycke



E 218
Ringscrew
Ringskruv

vario d2

Banner display/Banderolldisplay



Model example: Set M 1350, VA 5032, VA 5036
Panel recommendation: textile banner with hem
Modell exempel: Set M 1350, VA 5032, VA 5036
Rekommenderad panel: Textilbanderoll med hälsöm

- Create high impact presentations with your digital graphics. Floor stands, supports and beams are the three building blocks that make up this attractive display. The principle is very simple. The beams are slipped into the hems of the fabric graphics. Using the tensioner on the lower beam the textile banner can be pulled tight. Three versions are possible: as a support with a banner on one or two sides, or two supports with a banner in the middle.

- Succén med det textila digitaltrycket som sätter reklamen i fokus. Fottallrikar, dekorstolpar och sargar är de tre systembygghälsömmar. Princippet är mycket enkelt; sargerna dras in i textiltryckets hälsömmar. Textilbanderollen sträcks utmed den undre sargens spännlås. Det finns tre varianter: med en dekorstolpe och en- eller dubbelsidig banderoll. Eller med två stolpar och banderoll i mitten.



Tensioner and "Torx" E 14
Spännlås och torx E 14



Support-beam connector
Koppling stöd-sarg

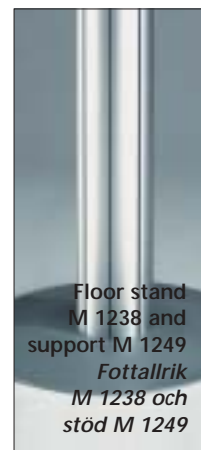

Floor stand M 1238 and support M 1249
Fottallrik M 1238 och stöd M 1249

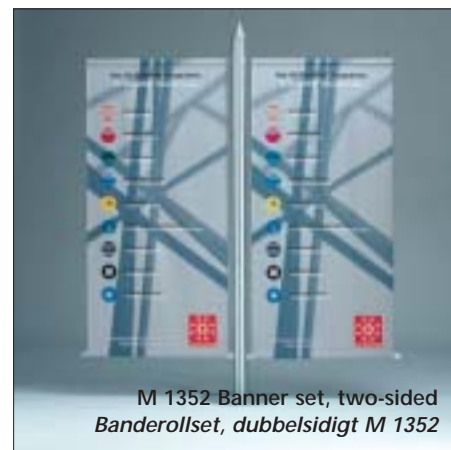

M 1352 Banner set, two-sided
Banderollset, dubbelsidigt M 1352

Basic Modules/Grundmoduler



M 1351
Bannerset, single-sided
1 Upright M 1249
1 Top M 1438
1 Base M 1238
2 Beams Z 363
Banderollset, ensidigt
1 Stolpe M 1249,
1 Top M 1438
1 Fot M 1238
2 Sarger Z 363

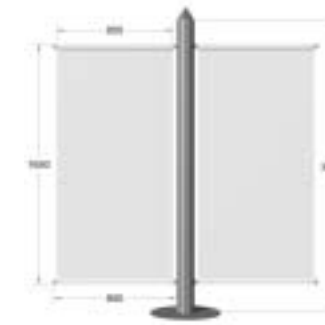

M 1352
Bannerset, two-sided
1 Upright M 1249
1 Top M 1438
1 Base M 1238
4 Beams Z 363
Banderollset, tvåsidigt
1 Stolpe M 1249,
1 Top M 1438
1 Fot M 1238
4 Sarger Z 363

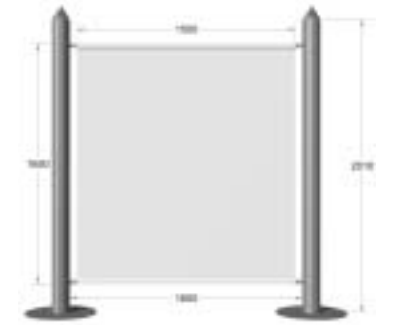

M 1350
Bannerset, mid section
2 Uprights M 1249
2 Top M 1438
2 Base M 1238
2 Beams Z 363
Banderollset, mittsektion
2 Stolpar M 1249
2 Toppar M 1438
2 Fötter M 1238
2 Sarger Z 363

Accessories/Tillbehör

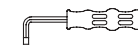

E14
Torx allen key
Torxnyckel



M 1438
Conical top, 80mm
Konisk topp, 80mm



M 1249
Upright round
80mm, 8 grooves L. 2010
Stolpe rund, 80mm,
8 spår L. 2010



M 1238
Foot plate for M 1249,
light grey
Fotplatta för stolpe
80mm, silver



Z 363
Beam, L. 850mm, 1 end tension lock, opposite end Z 970 endcap
Sarg, L. 850mm, klämbeslag på en sida, täckbricka Z 970 på motsatt sida



Z 365
Beam, L. 1600mm, tension lock both ends
Sarg, L. 1600mm, klämbeslag på båda sidor

More accessories, see page 7, 9 and 11/Ytterligare tillbehör se sid 7, 9 och 11.

Technical Information/Teknisk information

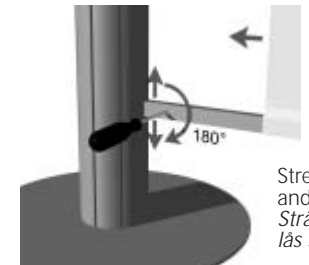
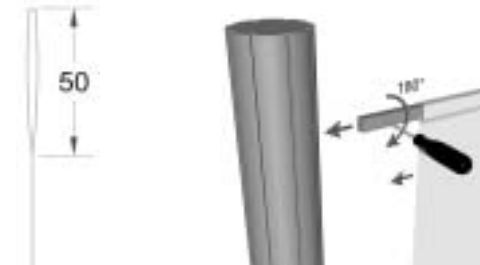
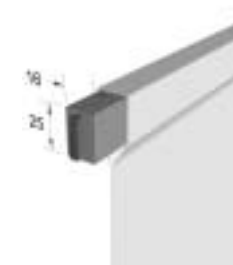

Stretch the fabric and lock the beam
Sträck textilen och lås sargen

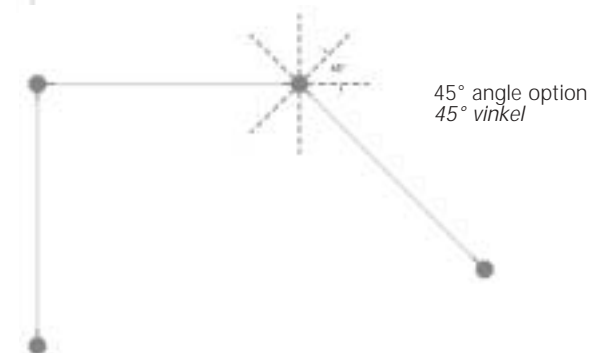

45° angle option
45° vinkel

vario d2

Counter/Disk

- A presentation solution as elegant as it is simple. The sidepieces are mounted in the grooves in one of the frames. Then the second frame is inserted down into the groove and the top is laid in place quickly and easily. A graphic can be applied and changed on the counter just as easy – no tools required. The vario d2 counter serves equally well as a temporary addition to existing sales areas. A superb solution that gets your message noticed, even when space is limited.

Accessories, including a bag and brochure holder are available for either side.

- En lika elegant som enkel lösning för din presentation. I spår monteras de båda gavelprofilerna i en av ramarna. Sedan förs den andra ramen ner och toppskivan läggs på plats snabbt och enkelt. Lika lätt kan budskapen appliceras och bytas på disken. Inga verktyg krävs.

vario d2 Counter fungerar lika bra som temporär komplettering till befintliga säljtor, som helt fristående mötesplats vid evenemang. En utmärkt lösning som skapar information som syns även i begränsade utrymmen.

Tillbehör som väskhållare och broschyrack finns till valfri sida.

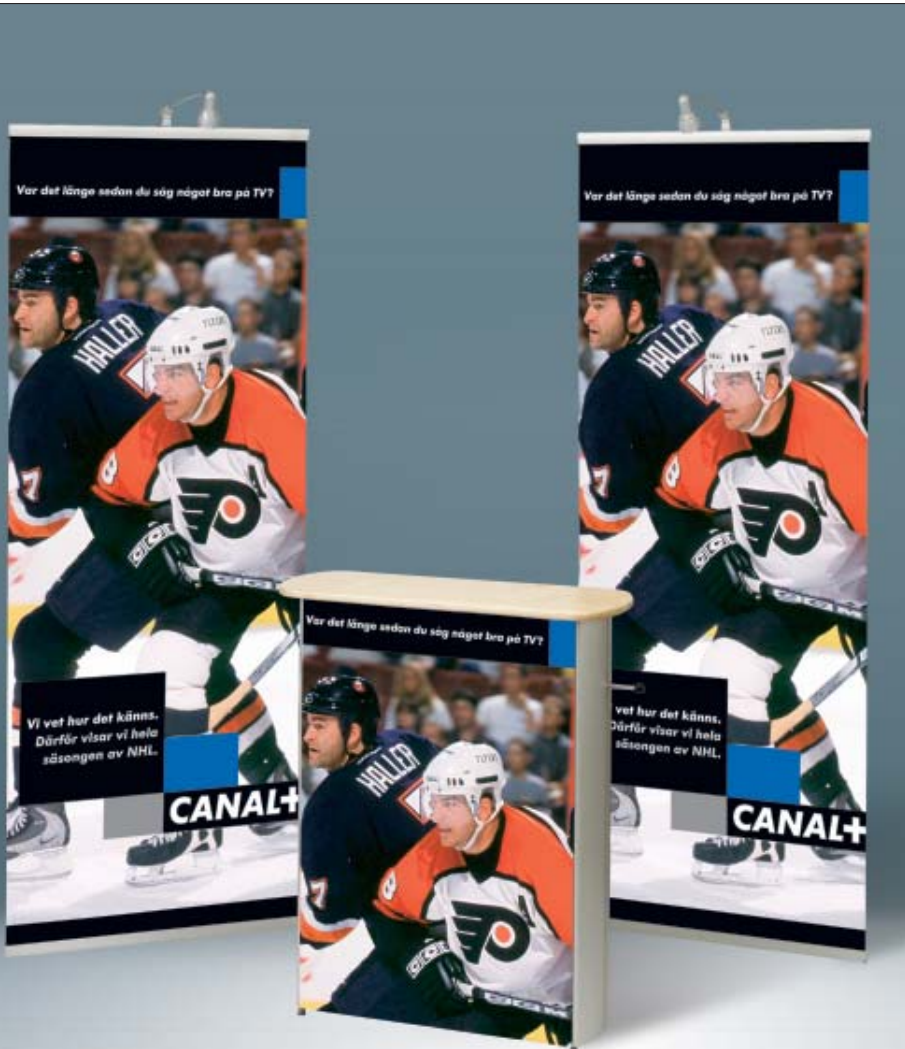

Model example: VA 1100 P1
Modell exempel: VA 1100 P1

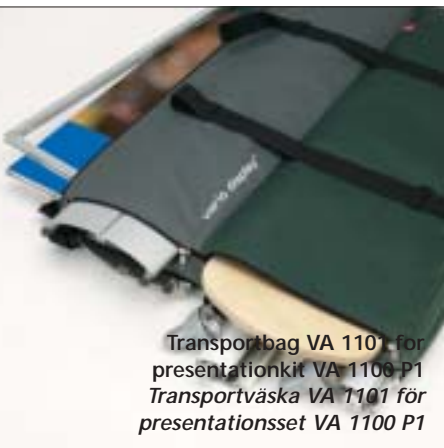

Transportbag VA 1101 for presentationkit VA 1100 P1
Transportväska VA 1101 för presentationsset VA 1100 P1



Magnetic application of panel
Magnetinfästning av bildpanel



Bag holder E 275
Påshållare E 275

Basic Modules/Grundmoduler



VA 1100
Counter, including transport bag
Disk, inklusive transportväska

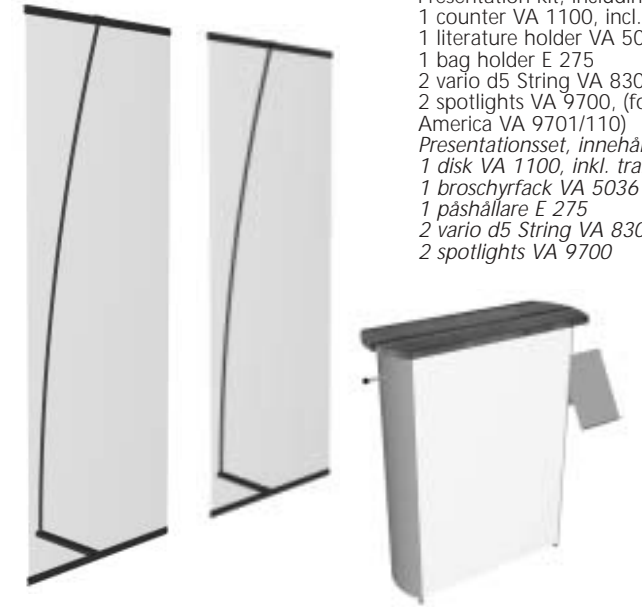

VA 1100 P1
Presentation kit, including:
1 counter VA 1100, incl. transport bag
1 literature holder VA 5036
1 bag holder E 275
2 vario d5 String VA 8300
2 spotlights VA 9700, (for North America VA 9701/110)
Presentationsset, innehållande:
1 disk VA 1100, inkl. transportväska
1 broschyrack VA 5036
1 påshållare E 275
2 vario d5 String VA 8300
2 spotlights VA 9700

Accessories/Tillbehör



E 275
Bag holder
Påshållare



VA 5035
Magnetic strip, 30m, self-adhesive
Magnetband, 30m, självhäftande

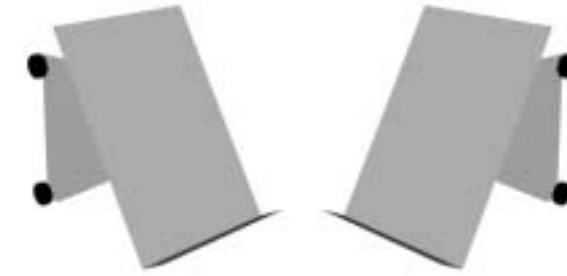

VA 5032
Literature holder, right side
Broschyrhylla, höger sida

VA 5036
Literature holder, left side
Broschyrhylla, vänster sida

VA 1101
Transport bag, L.1050, D.60, H.720mm
Transportväska, L.1050, B.60, H.720mm



Technical Information/Teknisk information



vario d3

Folding display/Vikskärm



Model example: VA 3006, VA 1005, VA 5036, 3 x VA 5021
Modellexempel: VA 3006, VA 1005, VA 5036, 3 x VA 5021

• A classic folding screen system developed for larger and more permanent presentations. Vario d3 features stable frames that both protect and hold your messages. Accessories such as brochure stands and spotlights complete the solid impression.

The classic construction makes it easy to take down and fold the screen, and to transport and store it between presentations.

The vario d3 is compatible with other OCTANORM systems, making it easier to sell around the message.

Vario d3 makes displaying and expanding a snap.

• Ett klassiskt vikskärmssystem som utvecklats för större och mer permanenta presentationer.

vario d3 har stabila ramar som både skyddar och bär upp budskapen.

Tillbehör som broschyrhyllor och spotlights fullbordar det gedigna intrycket.

Den klassiska konstruktionen gör det enkelt att fälla upp och vika ihop skärmen, som därför är lätt att transportera och lagra mellan presentationerna.

Genom att vario d3 är kompatibelt med övriga OCTANORMsystem, är det lättare att skapa säljande miljöer omkring budskapet.

Det är lätt att både exponera och expandera med vario d3.



Transport- and accessorybag
Transport- och tillbehörsväska



One or two panel option
Enkel- eller dubbelsidig display



Spotlight grips in to groove on frame
Spotlight krokas fast i spår på ramen

Basic Modules/Grundmoduler

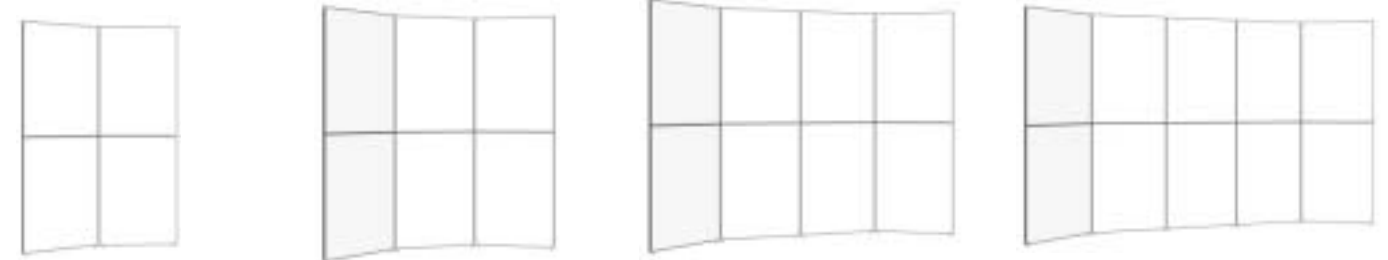

VA 3004/VA 3004 sw
4-Module, 700x1000 mm
4 modul, 700x1000 mm

VA 3006/VA 3006 sw
6-Module, 700x1000 mm
6 modul, 700x1000 mm

VA 3008/VA 3008 sw
8-Module, 700x1000 mm
8 modul, 700x1000 mm

VA 3100/VA 3100 sw
10-Module, 700x1000 mm
10 modul, 700x1000 mm

Standardcolor clear matt anodized, sw for black powdercoated. Measurement correspond to panel size.
Standardfärg naturanodiserad, sw för svartlackerat. Angivna mått avser storlek på panel.

Accessories/Tillbehör

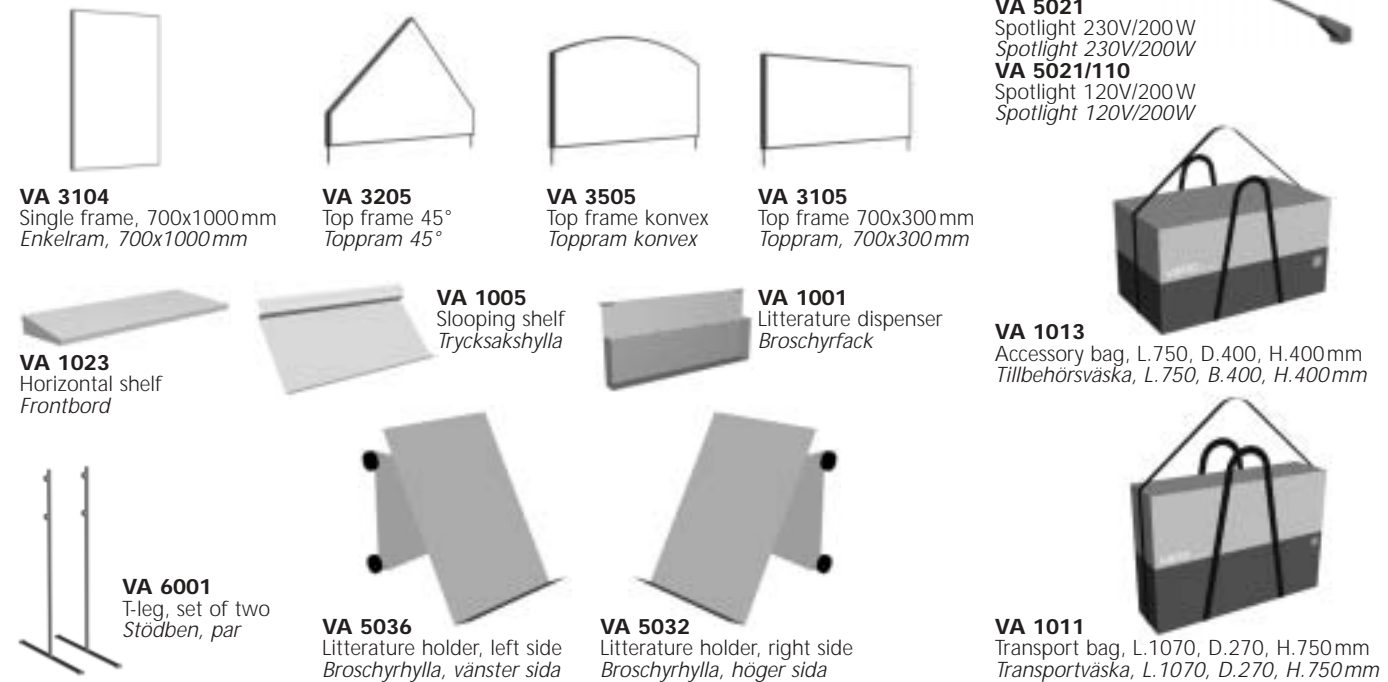

VA 3104
Single frame, 700x1000 mm
Enkelram, 700x1000 mm

VA 3205
Top frame 45°
Topram 45°

VA 3505
Top frame konvex
Topram konvex

VA 3105
Top frame 700x300 mm
Topram, 700x300 mm

VA 1023
Horizontal shelf
Frontbord

VA 1005
Sloping shelf
Trycksakshylla

VA 1001
Literature dispenser
Broschyrack

VA 1013
Accessory bag, L.750, D.400, H.400 mm
Tillbehörsväska, L.750, B.400, H.400 mm

VA 6001
T-leg, set of two
Stödben, par

VA 5036
Literature holder, left side
Broschyrhylla, vänster sida

VA 5032
Literature holder, right side
Broschyrhylla, höger sida

VA 1011
Transport bag, L.1070, D.270, H.750 mm
Transportväska, L.1070, D.270, H.750 mm

Technical Information/Teknisk information

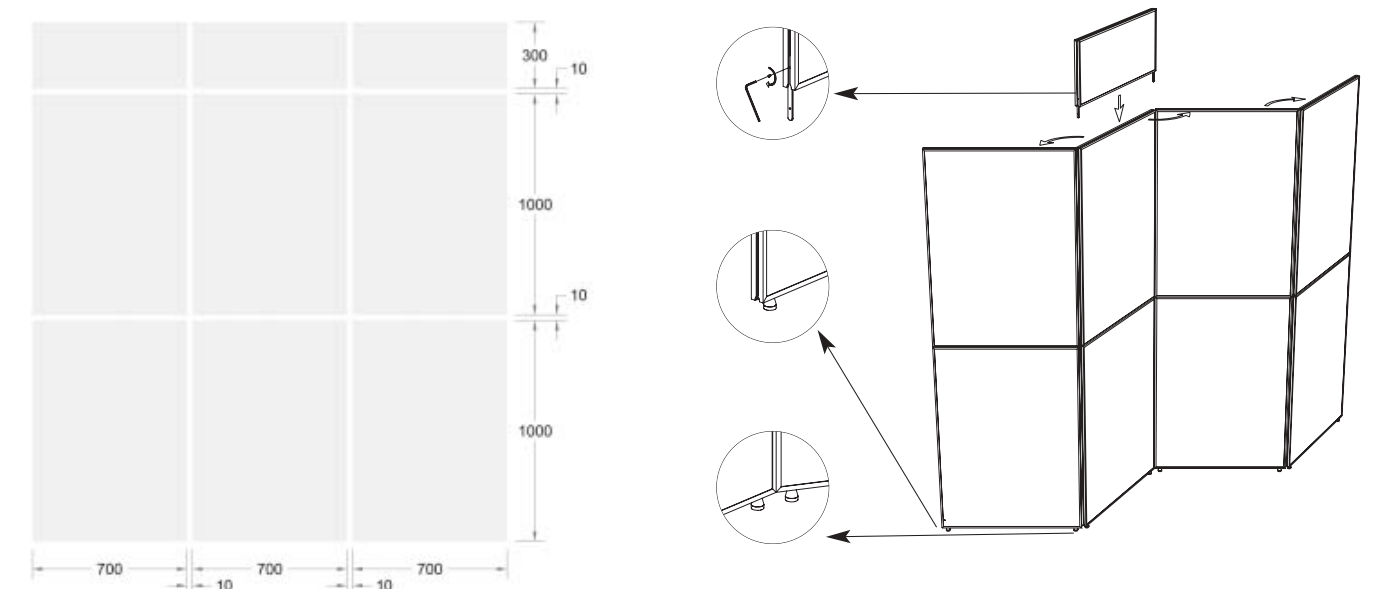

vario d4

Pop Up/Pop Up



Model example: VA 4833 P1, 2 x VA 5021, VA 8056
Modellexempel: VA 4833 P1, 2 x VA 5021, VA 8056

• When you want to make a fast, persuasive impression in places where crowds of people meet or pass by, vario d4 is the ultimate solution. Large-format text and pictures are displayed simply and ingeniously. Panel sections can be mounted rapidly without unsightly seams. The simple, lightweight construction makes vario d4 perhaps the most powerful support for your messages available anywhere.

The display, lighting and pictures are stored separately in the practical transport case, which is easily converted into a counter. The vario d4 is extremely compact when disassembled and requires little storage space.

• När du vill skapa intryck snabbt och övertygande där många människor möts eller passerar är vario d4 den ultimata lösningen. Lika enkelt som genialt exponeras bild och text i stora format. Bildväderna monteras snabbt utan störande skarvar.

Den enkla och lätta konstruktionen gör vario d4 till det kanske snabbaste och mest kraftfulla stödet för dina budskap.

I den praktiska transportlådan, som enkelt förvandlas till disk, förvaras display, belysning och bilder separat. Nedmonterad är vario d4 extremt kompakt och kräver lite lagerutrymme.

Basic Modules/Grundmoduler

CURVED SYSTEMS/SVÄNGDA SYSTEM



VA 4813 P1
1 Panel with endcaps
1 Panel med avslutningar



VA 4823 P1
2 Panel with endcaps
2 Paneler med avslutningar



VA 4833 P1
3 Panel with endcaps
3 Paneler med avslutningar



VA 4843 P1
4 Panel with endcaps
4 Paneler med avslutningar

STRAIGHT SYSTEMS/RAKA SYSTEM



VA 4713 P1
1 Panel with endcaps
1 Panel med avslutningar



VA 4723 P1
2 Panel with endcaps
2 Paneler med avslutningar



VA 4733 P1
3 Panel with endcaps
3 Paneler med avslutningar



VA 4743 P1
4 Panel with endcaps
4 Paneler med avslutningar

All systems illustrated are supplied excluding graphic panels/Alla system enligt ovan levereras utan bildpaneler.

Accessories/Tillbehör



VA 5021
Halogen light, 220V/200W
Halogen spot, 200V/200W
VA 5021/110
Halogen light, 120V/200W
Halogen spot, 120V/200W



VA 4615
Stabilizing foot
Stödfot



VA 8058
Panelwrap
Panelskydd

VA 8059
Panelbar bag
Panelpåse

VA 8055
Transport bag
Transportväska

VA 8056
Transport case
Transportlåda



VA 8066
Top panel for transportcase, cherry
Toppanel för transportlåda, körsbär
VA 8067
Top panel for transportcase, beech
Toppanel för transportlåda, bok
VA 8068
Top panel for transportcase, maple
Toppanel för transportlåda, lönn

Technical Information/Teknisk information

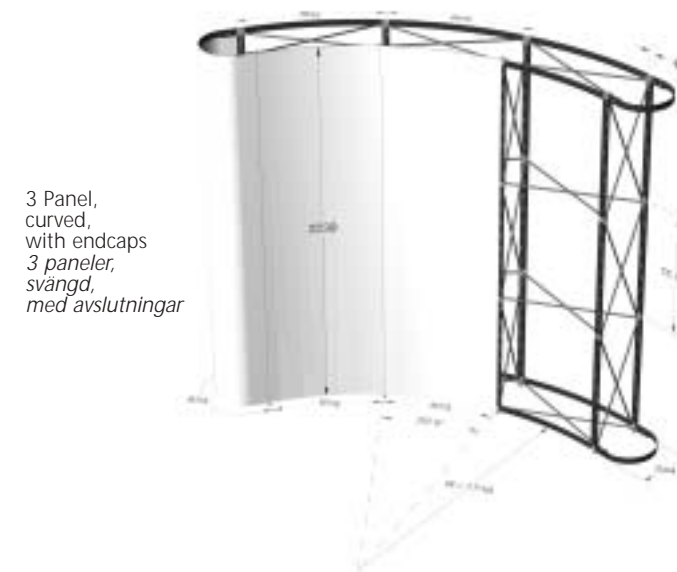

3 Panel, curved, with endcaps
3 paneler, svängd, med avslutningar



3 Panel, straight, with endcaps
3 paneler, raka, med avslutningar



Transportcase VA 8056, VA 8065
Transportlådor VA 8056, VA 8065



Panelwrap VA 8058 for graphic panel
Panelskydd VA 8058 för bildväder



Transport case VA 8065 with wrap and top panel
Transport låda VA 8065 med bildpanel och toppskiva

vario d4

Pop Up fabric/Pop Up textil



Model example: VA 4933, 2 x VA 5021
Modell exempel: VA 4933, 2 x VA 5021

- vario d4 creates a solid impression by displaying large-format pictures. The fabric display is a further enhancement of the Pop Up version. The unique advantage of the vario d4 fabric display is that it can be assembled in no time – an indispensable feature when the same message has to be presented at different meeting places on a tight schedule. The graphics are printed on fabric that stays on the unit even when disassembled. The specially designed fabric allows the large-format graphic to be displayed over and over with no loss of sharpness and a completely smooth surface.

- vario d4 skapar massiva intryck genom sin exponering av stora bilder. Textildisplayen är en vidareutveckling av Pop-Up-versionen.

Den unika fördelen med vario d4 textil är den extremt korta monterings tiden. Oumbärligt när samma budskap skall presenteras på olika mötesplatser under begränsad tid.

Bilden trycks i sin helhet på ett tyg som sitter fast på ställningen även i nedmonterat skick.

Tygets speciella kvalitet gör att den stora bilden gång på gång kan exponeras med bibehållen skärpa och en helt slät yta.



Transportbag VA 8055
Transportväska VA 8055



Stabilizing foot VA 4615
Stödfot VA 4615

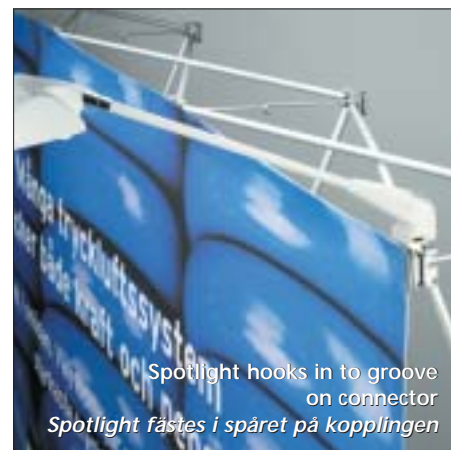

Spotlight hooks in to groove on connector
Spotlight fästes i spåret på kopplingen

Basic Modules/Grundmoduler



VA 4913
1x3 system

VA 4923
2x3 system

VA 4933
3x3 system

VA 4943
4x3 system

All systems illustrated are supplied excluding fabric panels/Alla system enligt ovan levereras utan textilpaneler.

Accessories/Tillbehör



VA 5021
Halogen light, 220V/200W
Halogen spot, 200V/200W
VA 5021/110
Halogen light, 120V/200W
Halogen spot, 120V/200W

VA 4904
Velcro for side cover, set of 4 pieces
Kardborrband för gavelmontering, set om 4 st

VA 8055
Transport bag
Transport väska

VA 8065
Transport case
Transportlåda



VA 4615
Stabilizing foot
Stödfot



Technical Information/Teknisk information



Velcro strip 40mm mounted on fabric panel
Kardborrband 40mm monterad på textilpanelen

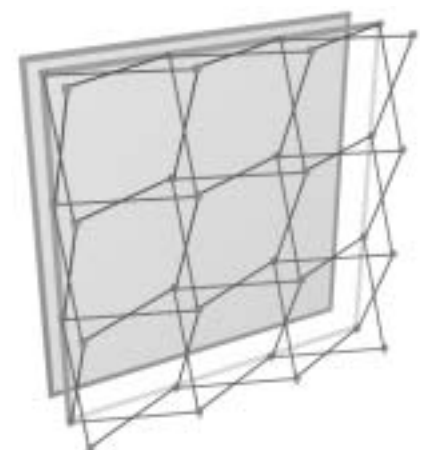

Correct panel size depends on stretchiness of fabric
Korrekt panelmått beror på tygets stretchförmåga

vario d5 Original

Promotion display/Promotion display



Model example: VA 8500, VA 8700
Panel recommendation: Drop paper, max. thickness 0.25 mm
Modell exempel: VA 8500, VA 8700
Rekommenderad panel: Drop Paper, max tjocklek 0,25 mm

- A real display innovation: vario d5 is simply rolled up in the carrying case, which is also the base. Putting it up and down takes just a few seconds. The display is made stable by the tensioning rod. The panels can be from 0.1 to 0.25mm thick and 600 or 800 mm wide: they can be placed next to each other to form a large area. To attract attention to one particular item, a spotlight can be hung on the tensioning rod.

- En verklig displayinnovation – vario d5 rullas enkelt ihop i transportboxen som samtidigt utgör sockel. Mycket enkel uppsättning och nedmontering som går på bara några sekunder. Displayen får sin stabilitet av spännstäng. De 600 eller 800 mm breda panelerna med en tjocklek på 0,1 till 0,25 mm kan även placeras bredvid varandra och på så sätt utökas till en stor yta. För att fokusera uppmärksamheten med ljus, kan en spotlight hängas in i spännstäng.



Plinth and panel
Sockel och panel



VA 8700
Spotlight
Spotlight



Top bar
Toppbom

Basic Modules/Grundmoduler



All systems illustrated are supplied excluding graphic panels/Alla system enligt ovan levereras utan bildpaneler.

Accessories/Tillbehör



Technical Information/Teknisk information



Spotlight bag attached to transport bag
Spotlightväska fäst vid transportväska

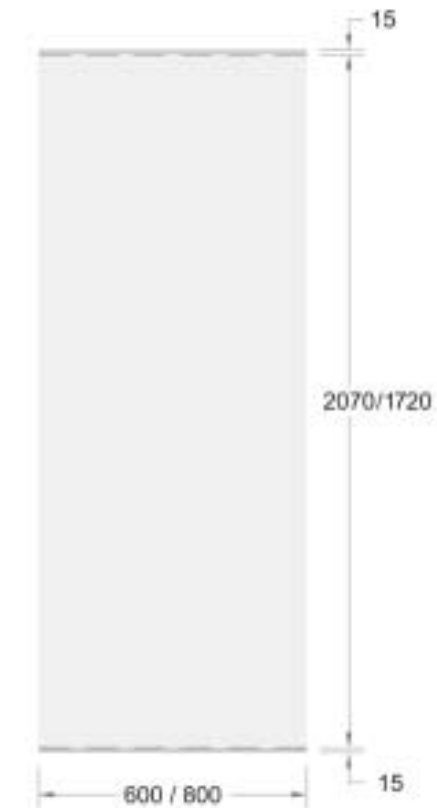
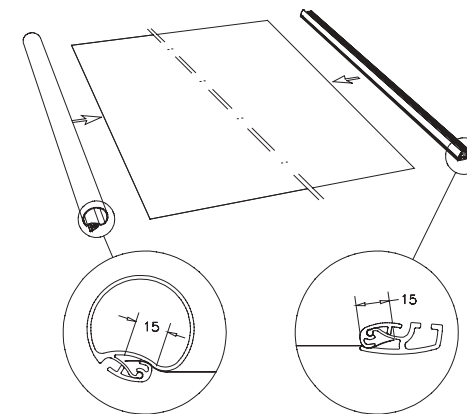

Top bar connector VA 5019, for connection of display
Toppboms skarv VA 5019 för ihopkoppling av displayer

vario d5 String

Promotion display/Promotion display



Model example: VA 8300, VA 9700
Panel recommendation: Banner, max. thickness 0,45 mm
Modell exempel: VA 8300, VA 9700
Rekommenderad panel: Banderoll, max tjocklek 0,45 mm

• The flexible suspension unit offers almost all the advantages of the Original vario d5 with one decisive difference: with just 400mm depth it is extremely economical on space. The d5 string display is quickly assembled and requires no tools. Banners, boards or posters are fixed with the practical clip profile. D5 String is available in 600, 800 and 1000 mm width. Special widths available on request. Its lightweight and handy dimensions make this display the optimum accessory for "quick-fix" promotions.

Attractive professional impact even on small budgets.

• Den flexibla motsvarigheten erbjuder nästan alla fördelarna hos originalet vario d5. Den övertygande skillnaden – med endast 400 mm uppställningsdjup är den synnerligen platsbesparande. Skruvanslutningen på sargen gör att d5 String-displayen snabbt byggs upp utan verktyg. Banderoll, plakat eller poster fästs med den praktiska clipsprofilen. d5 String finns i 600, 800 och 1000 mm bredd. Specialbredder kan offereras. Låg vikt och bekväma mått gör den här displayen till den optimala följeslagaren för snabba reklaminsatser.

Fördelaktig, professionell föreläsning även med liten budget.



VA 9700
Spotlight
Spotlight



Beam with screw. No tool assembly.
Sarg med skruv. Anslutning utan verktyg.



Rear view, narrow footprint.
Baksida, litet uppställningsdjup.

Basic Modules/Grundmoduler



VA 8302 1000x2140mm VA 8300 800x2140mm VA 8301 600x2140mm VA 8303 300x2140mm
VA 8312 1000x1310mm VA 8310 800x1310mm VA 8311 600x1310mm VA 8313 300x1310mm

All systems illustrated are supplied excluding graphic panels/Alla system enligt ovan levereras utan bildpaneler.

Accessories/Tillbehör



VA 5019
Top bar connector
Toppboms skarv



VA 8604
Transport bag 600/800mm
Transportväska 600/800mm
VA 8603
Transport bag 1000mm
Transportväska 1000mm



VA 6017
Wall hanger
Väggfäste



VA 8016
Top bar 1010mm
Toppbom 1010mm
VA 8014
Top bar 810mm
Toppbom 810mm
VA 8015
Top bar 610mm
Toppbom 610mm
VA 8017
Top bar 305mm
Toppbom 305mm
VA 8005
Top bar 5000mm/cut to size
Toppbom 5000mm/konfektionerau



VA 9612
Literature shelf
Broschyrhylla



VA 9700
Halogenspot 230V/75W
Halogenspot 230/75W



VA 9701
Halogenspot 12V/75W
Halogenspot 12V/75W
VA 9701/110
Halogenspot 12V/75W
Halogenspot 12V/75W



VA 5067
Mag-edge, set of 10m, north and 10m south pole
Mag-edge, set om 10m nordpol och 10m sydpol

Technical Information/Teknisk information

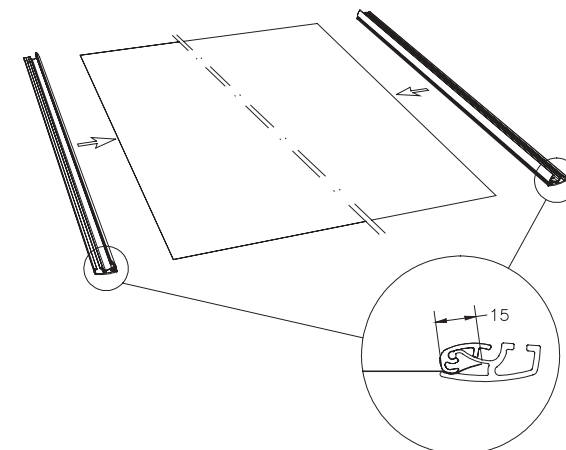

Top bar connector VA 5019, for connection of displays
Toppboms skarv VA 5019 for ihopkoppling av displayer



When using mag-edge, increase panel width with 10mm to line up with top and bottom bar
Vid användning av mag-edge öka panelens bredd med 10mm för att linjera med topp- och bottenprofil

vario d5 Pocket

Brochure display/Broschyr display

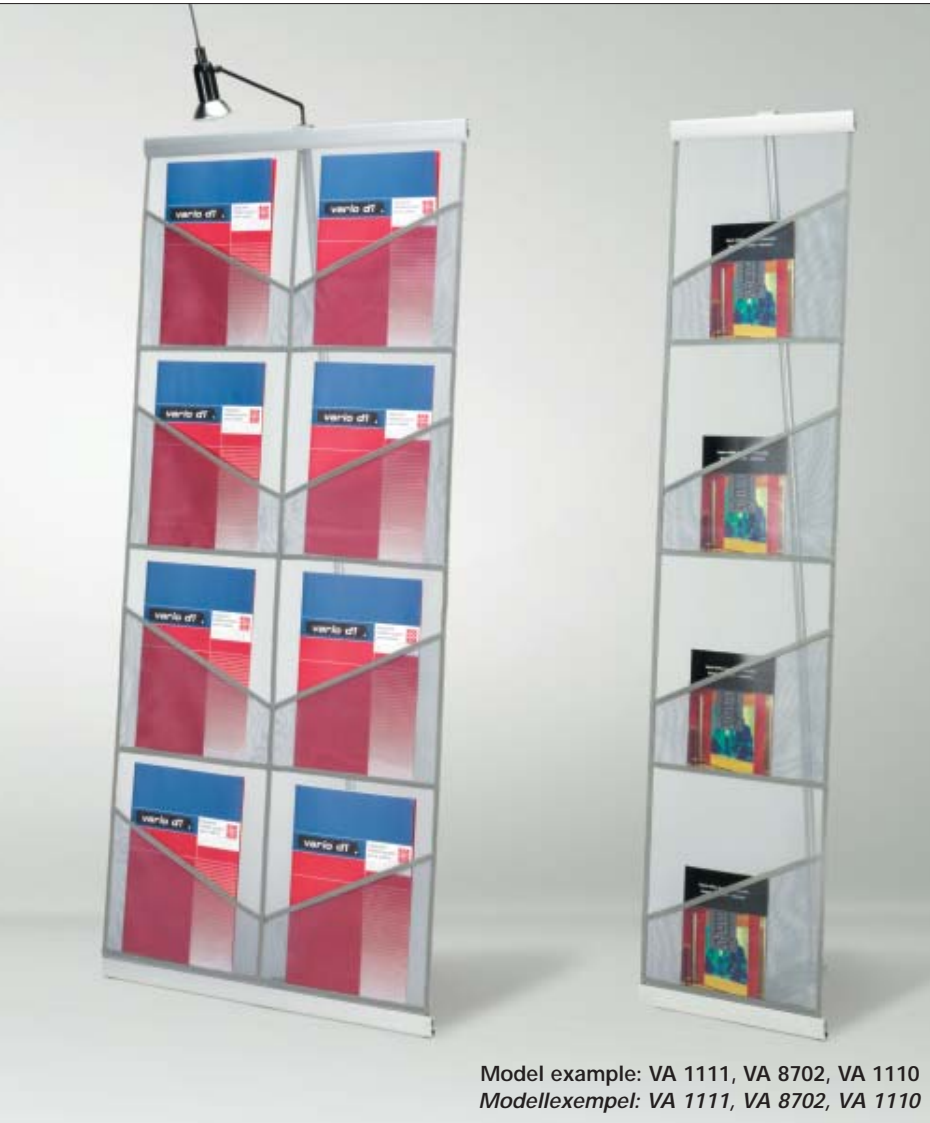

Model example: VA 1111, VA 8702, VA 1110
Modellexempel: VA 1111, VA 8702, VA 1110

• The brochure display is an essential and practical compliment to presentations using portable exhibition systems, heightening the overall impression. It takes only a few seconds to assemble, and then all you have to do is fill it with your important literature.

• Broschyrdisplayen är en självklar och praktisk komplettering till presentationer med bärbara utställningssystem för att förhöja helhetsintrycket. Flexibelt och enkelt ges möjlighet till effektiv och snabb exponering av de broschyrer som fördjupar och förstärker ditt budskap. Monteringen av displayen görs på några sekunder. Sedan är det bara att ladda med ditt angelägnade informationsmaterial. Displayen är som gjord för att locka människor att ta med sig dina budskap.

Basic Modules/Grundmoduler



VA 1110
Literature rack 4 sections
Broschyrhylla 4 fack



VA 1111
Literature rack 8 sections
Broschyrhylla 8 fack

Accessories/Tillbehör



VA 8702
Spotlight 230V/75W
Spotlight 230V/75W
VA 8702/110
Spotlight 120V/50W
Spotlight 120V/50W



VA 8710
Extra bulb 230V/75W
Ljuskälla 230V/75W
VA 8711
Extra bulb 120V/50W
Ljuskälla 120V/50W



VA 8605
Accessory bag, L.650, D.300, H.320mm
Tillbehörsväska, L.650, B.300, H.320mm

VA 8607
Transport bag 600mm
Transportväska 600mm



VA 8606
Literature bag, 3xA4
Broschyrfodral, 3xA4

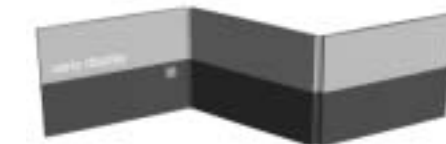

Fitted nylon cases
Anpassade nylonväskor



Mounting without using tools
Montering utan verktyg

Technical Information/Teknisk information

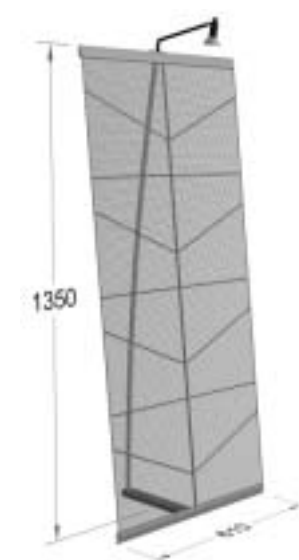
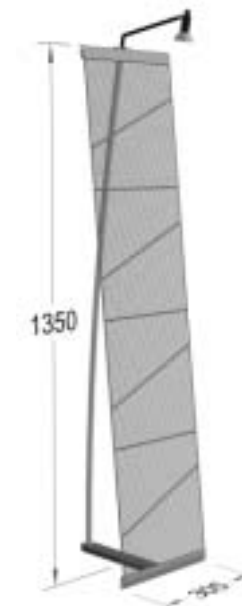

vario d7

Column display/Pelardisplay



- Strong impact, variable appearance. The vario d7 column display is available with or without lighting. The panels (high resistance foam or acrylic glass) can be quickly and simply replaced using the snap profile. Base and top plates join the two sides together to form an oval unit.

Anything presented in this column display will attract attention – and that means it has the greatest chance of success.

The matching counter completes your display area.

- *Kraftig framställning, variabelt utseende. Pelardisplayen vario d7 kan väljas med belysning som tänds och släcks med en fotbrytare. Eller utan belysning. Panelen byts snabbt och enkelt tack vare clipsprofilerna. Täckplattor uppe och nere sammanfogar de båda sidorna till en oval enhet.*

Det som presenteras i en pelardisplay syns verkligen – och har därmed de bästa möjligheterna att blir en framgång.

Den passande disken kompletterar d7 så att det blir ett "lysande" reklamset.

Model example: VA 7500, VA 7700

Panel recommendation: without lighting: high resistance foam board max 2 mm
with lighting: acrylic glass max. 1.5 mm

Modell exempel: VA 7500, VA 7700

Rekommenderad panel: utan belysning: hårdskumsplatta max 2 mm



VA 7300
Counter/Disk



VA 7700
Lighting set incl. auxiliary switching unit
Belysningsset



VA 7500, VA 7700

Basic Modules/Grundmoduler



VA 7500
Basic set (without panels)
Grundset (utan paneler)



VA 7700
Illumination set 230V/58W
Belysningsset 230V/58W



VA 7300
Counter set incl. illumination 230V/18W and 4 panels A1
Disk inkl. belysning 230V/18W och 4 paneler A1

Accessories/Tillbehör



VA 7501
Top panel VA 7500, black
Toppskiva till VA 7500, svart



VA 5032
Literature holder, right side
Broschyrhylla, höger sida



VA 5036
Literature holder, left side
Broschyrhylla, vänster sida

Technical Information/Teknisk information

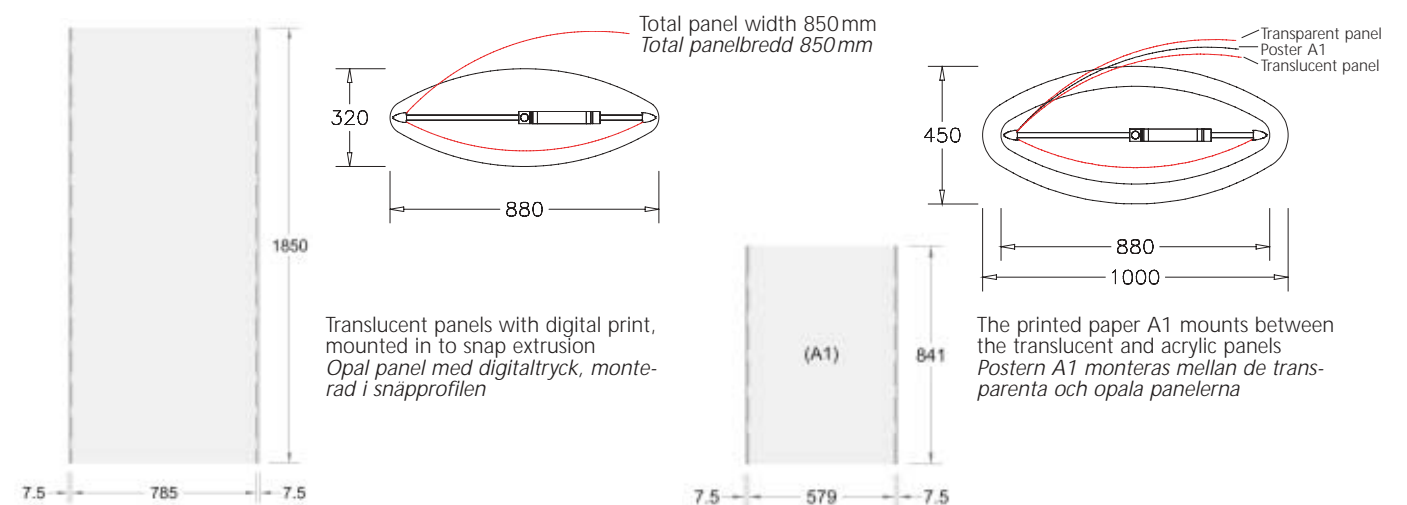

vario d10

Rollup display/Rullgardinsdisplay

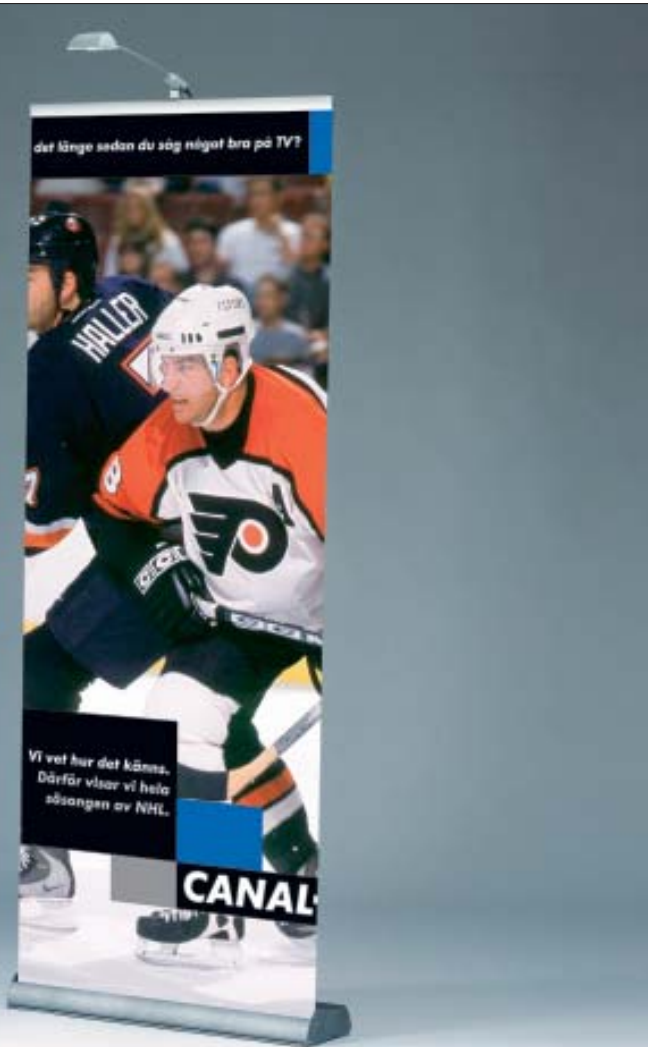

Model example: VA 9522, single-sided
Modell exempel: VA 9522, ensidig

- Fast, effective, manageable: this display can be rolled out in seconds, anywhere, anytime. There is enough space in the plinth to store the spotlight. (Only on the single-sided unit.) The whole thing fits into a handy carrying bag. The standard 840 and 940 mm widths can be combined using connectors and expanded as you like. A quick alternative, which is always at the ready.

- Snabb, effektiv, hanterlig. Så fungerar en display som inte är rädd för att uppträda på olika platser. Tvärtom – vario d10 är gjord för att sekundsnabbt kunna rullas upp ur boxen och vara på plats någon annanstans. Till och med belysningen finns med. Spotlighten förvaras i sockeln. (Enbart enkelsidig display.) Allt får plats i en lätthanterlig transportväska. De båda standardbredderna 840 och 940 mm kan kombineras med kopplingar och utökas till önskad bredd. Ett snabbt medium som alltid finns till hands och som därför ger ett flexibelt användningsområde.



VA 9701
Spotlight
Spotlight



Assembled in seconds
Sekundsnabb uppbyggnad



Fixing and cable run
Fäste och kabeldragning

Basic Modules/Grundmoduler



SINGLE SIDED/ENKELSIDIG
VA 9521
Roll up display for 1 panel,
940x2150mm
Rullgardins display för 1 panel,
940x2150mm
VA 9531
Roll up display for 1 panel,
940x2150mm, incl. transport bag
Rullgardins display för 1 panel,
940x2150mm, inkl. transportväska
VA 9522
Roll up display for 1 panel,
840x2150mm
Rullgardins display för 1 panel,
840x2150mm
VA 9532
Roll up display for 1 panel,
840x2150mm, incl. transport bag
Rullgardins display för 1 panel,
840x2150mm, inkl. transportväska



DOUBLE SIDED/DUBBELSIDIG
VA 9523
Roll up display for 2 panels,
940x2150mm
Rullgardins display för 2 paneler,
940x2150mm
VA 9533
Roll up display for 2 panels,
940x2150mm, incl. transport bag
Rullgardins display för 2 paneler,
940x2150mm, inkl. transportväska
VA 9524
Roll up display for 2 panels,
840x2150mm
Rullgardins display för 2 paneler,
840x2150mm
VA 9534
Roll up display for 2 panels,
840x2150mm, incl. transport bag
Rullgardins display för 2 paneler,
840x2150mm, inkl. transportväska

Measurement correspond to visible surface, total panel length 2300mm/Angivna mått avser synlig yta, total panelhöjd 2300mm.

Accessories/Tillbehör



VA 9602
Transport bag single sided 950mm
Transportväska enkelsidig 950mm
VA 9603
Transport bag single sided 850mm
Transportväska enkelsidig 850mm
VA 9604
Transport bag double sided 950mm
Transportväska dubbelsidig 950mm
VA 9605
Transport bag double sided 850mm
Transportväska dubbelsidig 850mm



VA 9010
Top bar 940mm
Toppbom 940mm
VA 9019
Top bar 840mm
Toppbom 840mm



VA 9700
Halogenspot 230V/75W
Halogenspot 230/75W



VA 9612
Literature shelf
Broschyrhylla



VA 9611
Horizontal shelf 850mm,
incl. vertical extrusions, 2 brackets and
aluminium shelf
Fronthylla 850mm, inkl. vertikala profiler,
2 konsoller och aluminiumhylla



VA 9701
Halogenspot 12V/75W
Halogenspot 12V/75W
VA 9701/110
Halogenspot 12V/75W
Halogenspot 12V/75W



VA 5019
Top bar connector
Toppboms skarv

Technical Information/Teknisk information

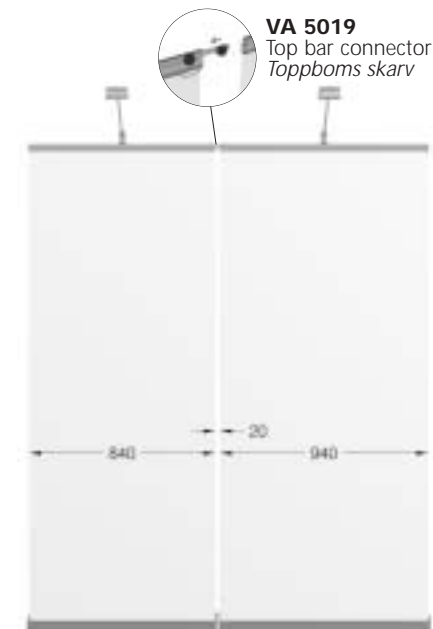

VA 5019
Top bar connector
Toppboms skarv



Spotlight VA 9701 fits in to the base on single sided display during transportation and storage
Spotlight VA 9701 ryms i sockeln på enkelsidig display under transport och lagring

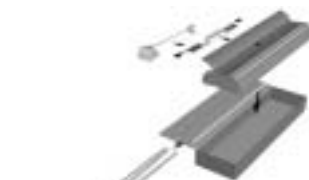

Fitted nylon bags with separate compartment for pole
Transportväska med separat fack för stödpinne



Easy access for maintenance
Lättillgängligt underhåll

OCTANORM® Product Line.
OCTANORM®-Sortimentet.



Wall Systems
Väggsystem



Ceiling Systems
Taksystem



Floor Systems
Golvsystem



Two Storey Systems
Två vånings system



Lighting Systems
Belysningsystem



Furniture and Interior Design Systems
Möbel- och Inredningssystem



Shelving Systems
Hyllsystem



Graphic Display and Exhibit Systems
Display- och Utställningssystem



Software & Service
Software & Service

Expertise with Creative Systems
Kompetens för kreativa system

